

Leading Edge Powder Processing Technology

Gericke

POWDER PROCESSING SOLUTIONS FOR BATTERY CELL PRODUCTION

Gericke's proven bulk material handling solutions, which includes conveying to the feeding and mixing of fine powders, has the capability to handle toxic, high value and sensitive raw materials for anode and cathode production in a safe and efficient way.



BATTERIES MOVE THE WORLD

The efficient production of batteries, used for many different purposes, is a key in the drive to meet our climate change promises and the success of renewable energies. Additionally, the reuse of battery components will ensure a sustainable path for this type of high value energy.

Gericke equipment is used in various parts of battery production including the feeding of rotary kilns and extruders for raw material manufacture to the storage, delivery and blending necessary for anode and cathode slurry manufacturing. Gericke can also provide systems to help in the recovery and the successful recycling of precious rare earth elements.



THE EXPERTS IN POWDER HANDLING

Benefit from Gericke's wealth of experience in powder handling, dosing, pneumatic conveying and mixing technology. Our group knows how to efficiently handle very fine or cohesive powders, as well as abrasive, sensitive, toxic and explosive materials.

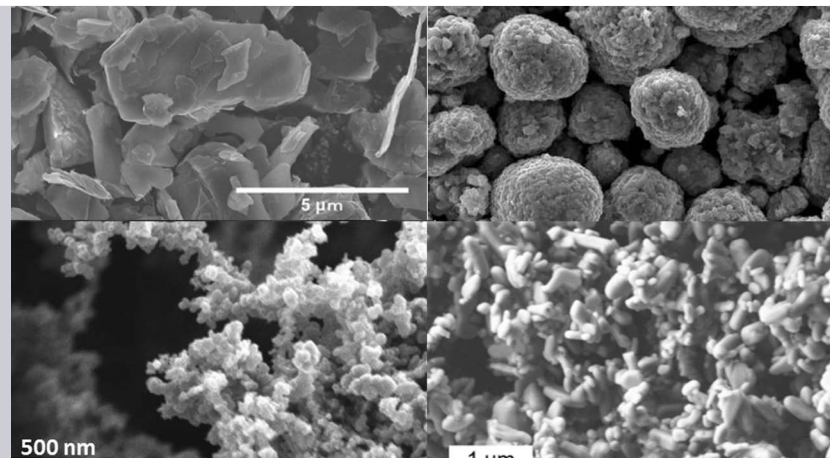

YOUR ENGINEERING PARTNER

Save time and money with Gericke's engineering expertise and thorough project management. Our support also covers risk assessment, data integration and energy efficiency. The Gericke Group is also available for consultation during a pre-engineering study!

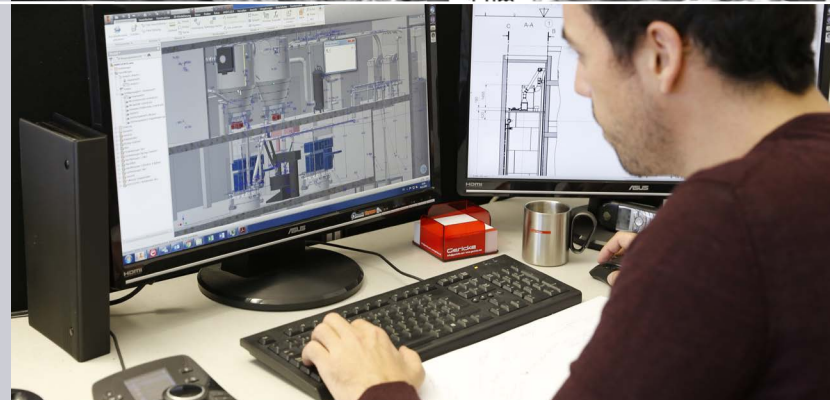

FIT FOR YOUR NEEDS

SAFE TO OPERATE, FOR THE PRODUCTION AND THE ENVIRONMENT!

Gericke engineers its solutions to protect you and our planet! Since some of the raw materials are hazardous to health, our systems are designed to be dust-tight and fully compliant to containment standards. We use proven sealing technologies also to ensure that moving parts are perfectly tight.



HANDLE PRECIOUS RAW MATERIALS THE RIGHT WAY!

Gericke metering systems ensure a very high consistent quality in the processing of active materials such as NMC, NCA, LFP, LCO, LFP, binders, conductive carbon blacks, graphite, silicone, carboxymethyl cellulose (CMC) and polyvinylidene fluorides (PVDF).



AVOID METAL CONTACT AND CONTAMINATION

Our solutions are available in special executions to avoid metallic contamination, helping you to achieve a superior high quality end product.

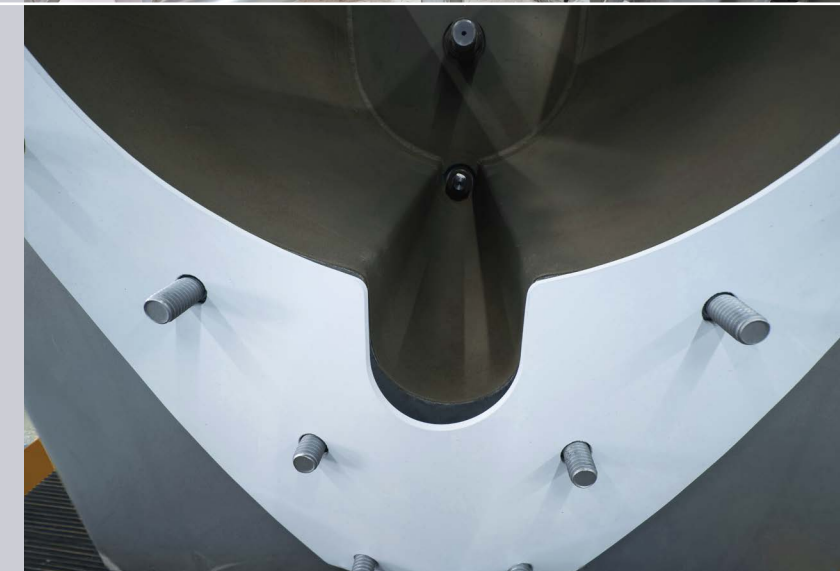

YOUR GLOBAL PARTNER FOR ALL ASPECTS OF POWDER PROCESSING

1 Bulk Handling: Safe and contained

- Gericke handling systems combine key needs: Preserve material quality, save energy, protect the environment and the workers.

2 Accurate feeding into mixing, extrusion and grinding

- Reliable and accurate, Gericke covers a broad range of feeding and dosing requirements.
- Extruders and mixers require accurate control of several material streams. Our multichannel controllers offer a cost effective solution.

3 Automation: Integrated and preconfigured

- Our understanding of the fundamental processes of bulk handling, feeding, mixing and conveying together with our competence in electrical engineering and automation makes us the ideal partner to supply you with complete turn-key systems.

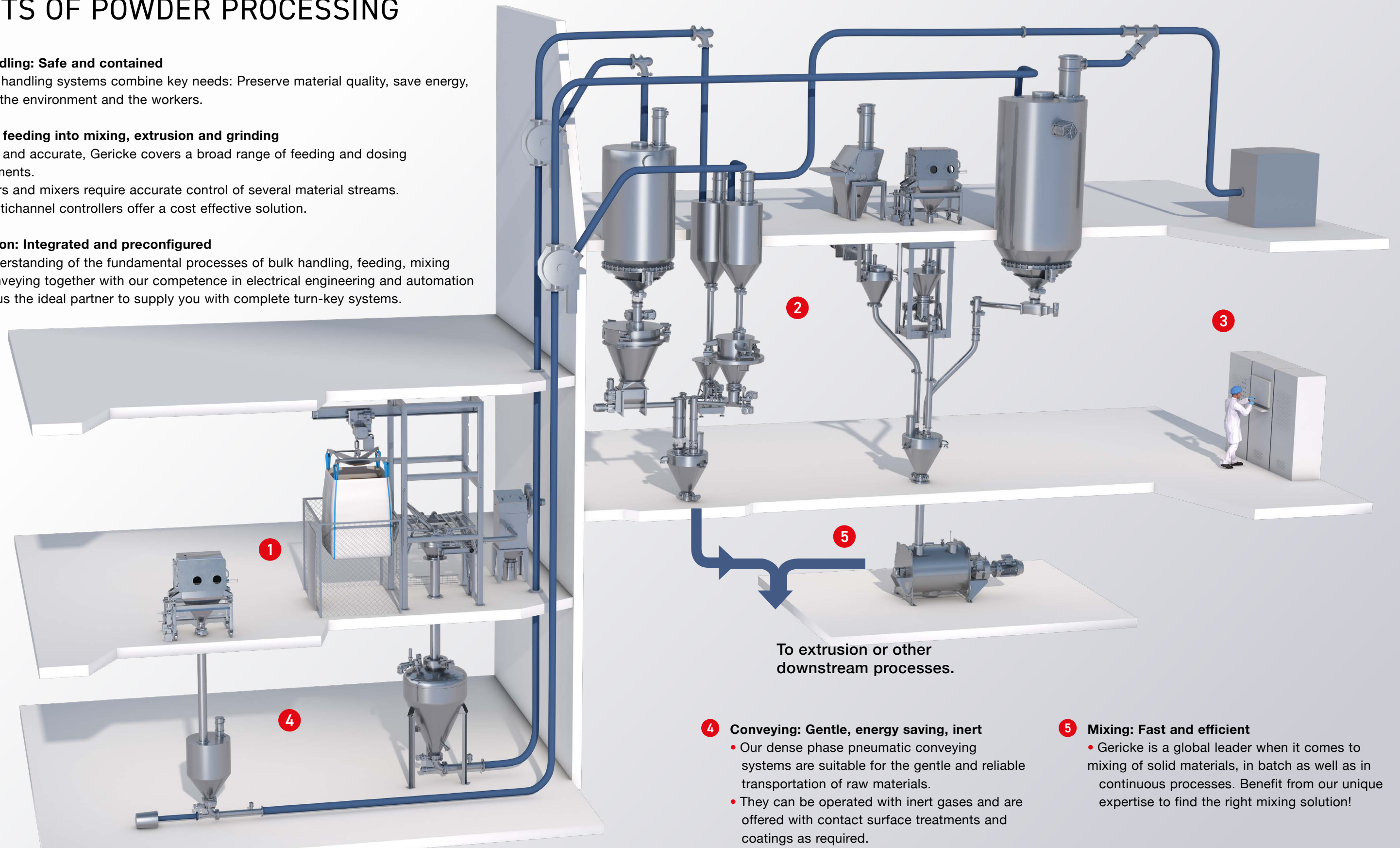

To extrusion or other downstream processes.

4 Conveying: Gentle, energy saving, inert

- Our dense phase pneumatic conveying systems are suitable for the gentle and reliable transportation of raw materials.
- They can be operated with inert gases and are offered with contact surface treatments and coatings as required.

5 Mixing: Fast and efficient

- Gericke is a global leader when it comes to mixing of solid materials, in batch as well as in continuous processes. Benefit from our unique expertise to find the right mixing solution!

DENSE PHASE PNEUMATIC CONVEYING

Automated, robust, efficient, safe, reliable

For gentle and energy efficient product transfer with no demixing, dense phase conveying is the perfect solution to preserve your materials.

- Low velocity convey speeds give much reduced wear and chance of metal contamination
- Gas and dust tight systems that result in no pollution - protecting the local environment and system operators
- High solids concentration with low gas consumption leads to reduced operation costs
- Utilizing dried pressurized air or inert gases with low air humidity (<1g/m3) prevents problems with moisture / humidity
- Additional wear protection and coating solutions available
- Best in class availability with long operating life all combined with minimal maintenance

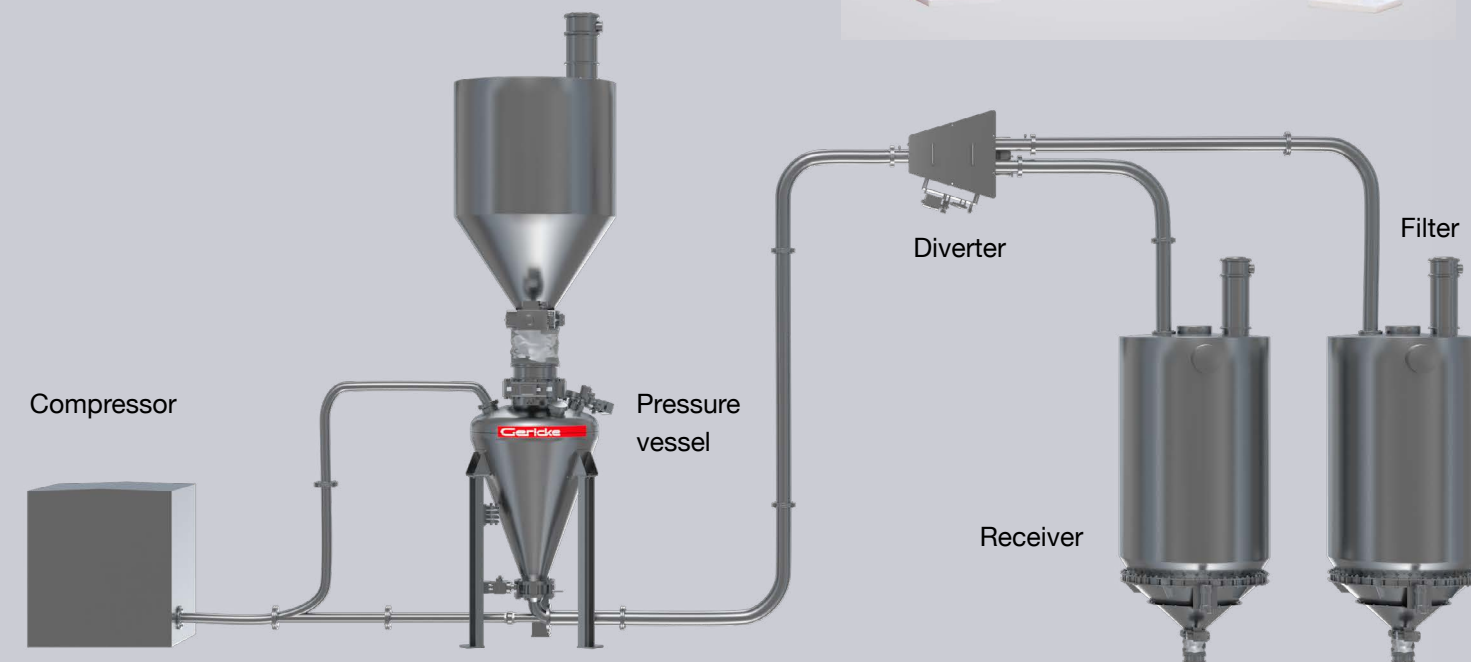

DILUTE PHASE PNEUMATIC CONVEYING

Easy to implement and versatile

Lean or dilute phase conveying can be the perfect solution for many nonsensitive powders and bulk materials.

- Gericke lean phase conveying systems are economical and reliable solutions
- Systems can be setup in vacuum or overpressure configurations
- Simple setup of the system
- Little headroom necessary for installation
- The throughput can be varied by controlling the rotational speed of the rotary valve
- Gericke RotaVal rotary valves are available as easy to clean extractable units, with re-enforced replaceable blade inserts or with special coatings

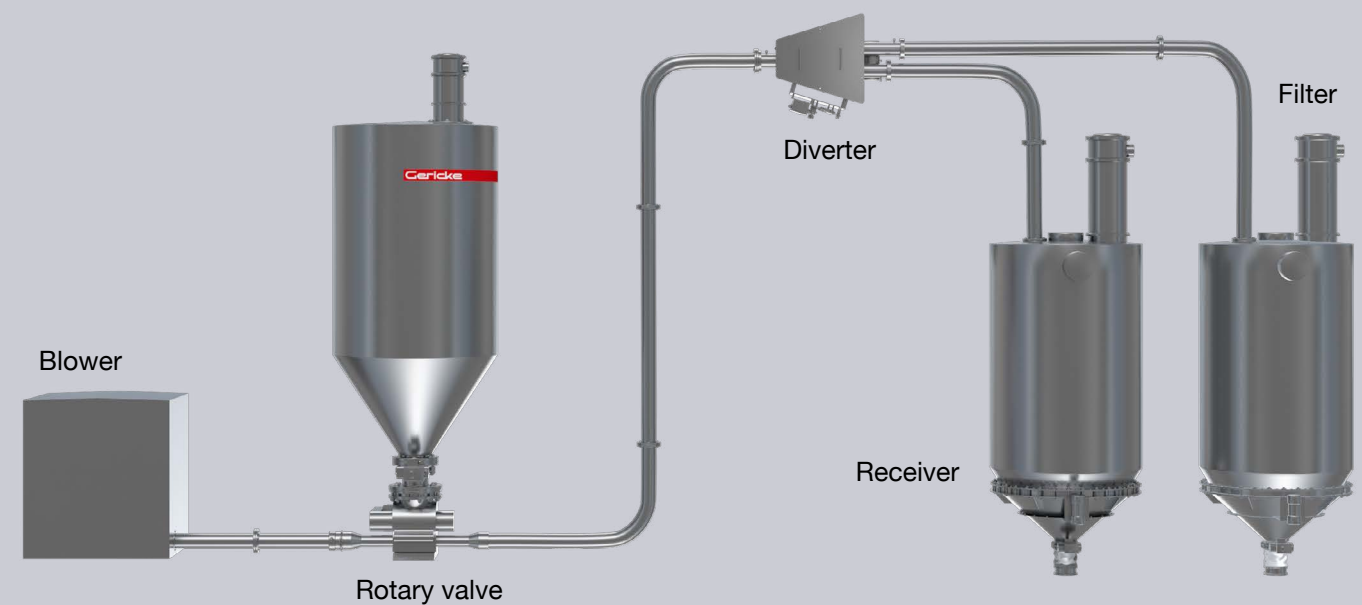

VOLUMETRIC AND GRAVIMETRIC FEEDING AND DOSING

MAKE NO COMPROMISE ON ACCURACY & TIGHTNESS!

Gericke feeders combine simple operation with easy cleaning and minimal maintenance. Thanks to its modular design, it is versatile and highly adaptable to suit both the bulk material and the process.

Tight. Period.

Many Gericke feeders are available with an advanced sealing concept. Using lip seals on the drive shafts of the feeding tool and intruder, the feeder is extremely tight, even at the critical interfaces to the moving parts. This makes our feeders a perfect dosing device in industries with demanding OEL requirements.

Designed for highest accuracy

Gericke's gravimetric feeders combine advanced volumetric feeders with precise load detection and sophisticated controls to guarantee the highest accuracy for all loss-in-weight applications.

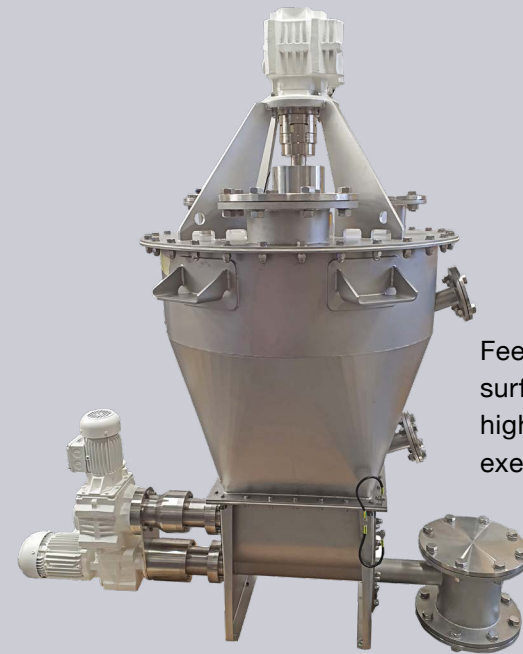

Feeder with internal surface coating in high temperature execution.



MULTIPLE FEEDERS NEEDED?

Gericke has been a specialist for highly accurate feeding and dosing even under the harshest conditions. With our Model GUC-F multichannel controller you can now easier than ever control different feeders with a single state-of-the-art, flexible control solution.



HIGH TEMPERATURES? NO WORRIES.

Gericke has developed an extremely accurate metering system for the direct dosing of material into high temperature rotary kilns used in the synthesis of materials in the anode and cathode production.

From there, Gericke also offers metering systems for the delivery of the high temperature powders for grinding.

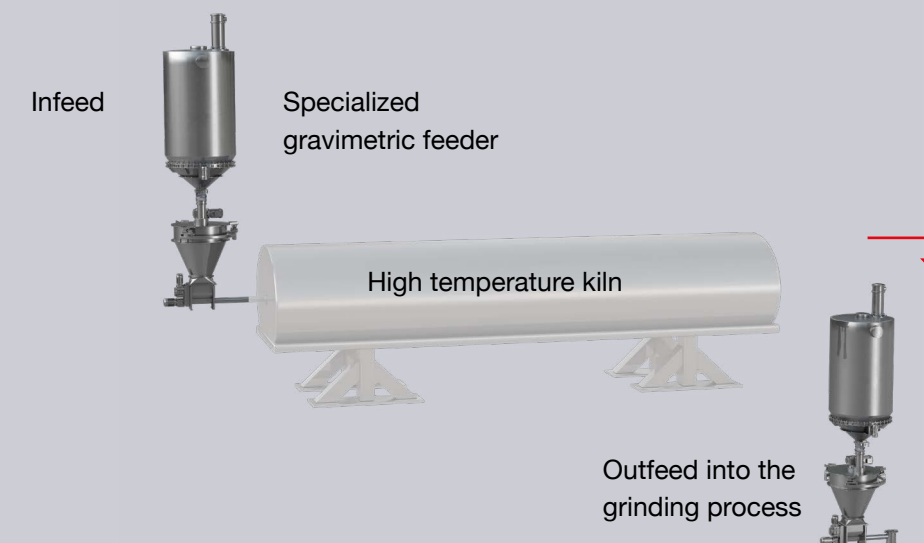

BATCH AND CONTINUOUS INLINE MIXING SOLUTIONS

The highest homogeneity, even with microingredients. Easy to clean, fast and effective but nevertheless gentle, energy efficient and space saving. Fully integrated with feeders and with your entire process: That is mixing technology from Gericke.

Mixing: Fast and efficient

Gericke covers inline mixing ranges from 1 kg/h to more than 100,000 kg/h for powders, pellets, granules, flakes, particles and liquid additions. Gericke's unique experience also includes reaction processes such as agglomeration, coating and heat transfer.



Meeting all requirements

- Available in continuous and batch executions
- Batch sizes from 1 l up to 40'000 l
- Integrated with Gericke feeding and dosing equipment
- Optional cooling and heating jackets
- High product temperature executions
- Special surface coatings



READY FOR DRY PROCESSING?

Gericke has gained expertise in the mixing of lubricants into a powder stream in the pharmaceutical industry. If liquid binders are replaced by new advanced dry binder materials, you may profit from our experience handling fine powders continuously, under containment conditions and to a maximum degree of mixing.



NEED FOR SMALL BATCHES?

The GMS Compact Mixer brings the superb mixing quality and speed of the GMS family to laboratory and R&D size, with useable volumes from 1 to 20 l. The industrial design also makes it a perfect fit for pilot plants and small production batches.

- Optional cooling and heating jackets
- High product temperature executions
- Interchangeable mixing chambers





TEST CENTER

Tests on an industrial scale reduce planning time and increase process safety!

Test Center in Switzerland, France, England, Brazil, USA and Singapore are available for customer tests under near-production conditions. The test centers are equipped with original machines and our experienced specialists design the test layout according to your specifications and perform the tests.

- Testing of machines and prototypes with original products
- Checking of performance ranges and accuracies
- Testing of the interaction of multiple machines
- Gaining of experience for product processing
- Sampling for laboratory tests and market response
- Customer training

SERVICE

Worldwide support for commissioning, maintenance and service.

The Gericke Group puts a priority on punctual delivery, reliable assembly and thorough assembly monitoring. With well-planned commissioning and intensive on-site training we provide the prerequisites for a smooth production start-up. Our service team and global spare parts service combine to ensure long service life and high availability of systems with consistent product quality.

YOUR PARTNERS WORLD-WIDE

Switzerland

Gericke AG
T +41 44 871 36 36
gericke.ch@gerickegroup.com

Germany

Gericke GmbH
T +49 77 31 929 0
gericke.de@gerickegroup.com

France

Gericke SAS
T +33 1 39 98 29 29
gericke.fr@gerickegroup.com

United Kingdom

Gericke Ltd.
T +44 16 13 44 11 40
gericke.uk@gerickegroup.com

Netherlands

Gericke B.V.
T +31 33 25 42 100
gericke.nl@gerickegroup.com

USA

Gericke USA, Inc.
T +1 855 888 0088
gericke.us@gerickegroup.com

Brazil

Gericke Brasil Ltda.
T +55 11 2598 2669
gericke.br@gerickegroup.com

Singapore

Gericke Pte Ltd.
T +65 64 52 81 33
gericke.sg@gerickegroup.com

China

Gericke (Shanghai) Pte Ltd.
T +86 21 3306 3395

Indonesia

Gericke Indonesia
T +62 21 2958 6753

Thailand

Gericke Thailand
T +66 95 464 6161

Malaysia

Gericke Malaysia
T +60 11 51678133
gericke.my@gerickegroup.com

For all other countries please contact Gericke AG in Switzerland.

GERICKEGROUP.COM

Gericke